

# 0.2 mm Pitch, 0.65 mm Height, Top Contact, Back Flip FPC Connector

## FH53 Series

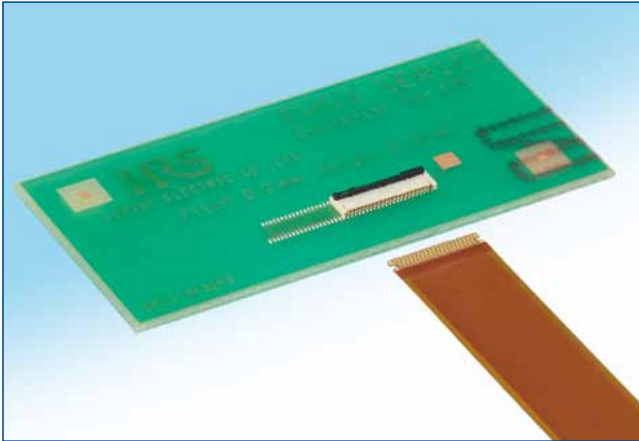

Maximizes board space by utilizing its low profile, and narrow pitch/depth

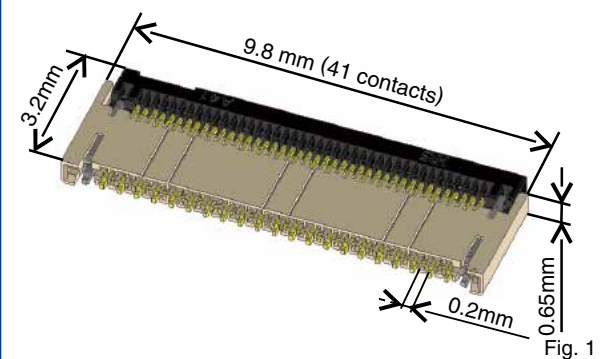

### Features

#### 1. Low-profile, top contact FPC connector

Its super thin design produces a 0.65 mm mounted height. (Fig. 1)

#### 2. Maximizes board space

Its narrow pitch (0.2 mm) and depth (3.2 mm, with the actuator in the locked position) combine to maximize valuable board space. (Fig. 1)

#### 3. Supports high-speed transmissions

By utilizing differential pairs of identical contacts (even-even contacts or odd - odd contacts) these connectors are able to provide superb transmission characteristics and have achieved compliance with the eDP (ver. 1.3), and MIPI (D-PHY) standards. (Fig. 2)

#### 4. Multi-functional chucking metal

The chucking metal provides several functions all in itself. It allows this connector to accept horizontal FPC insertions; it generates a clear tactile click when the FPC is inserted. It also provides increased retention force on the FPC after insertion and prior to the lock being engaged, because the metal was designed to allow the FPC tabs to secure itself on it. (Fig. 3)

#### 5. Simplified FPC insertion

Large mating guides help to simplify the FPC insertion process. These guides are located on both sides of the housing. (Fig. 4)

#### 6. Reduces assembly procedures

The actuator is delivered in the open position and allows you to immediately insert the FPC.

#### 7. Fully molded structure aids PCB layout

The bottom of this connector is enclosed by a fully molded structure that protects the contacts and removes any restrictions from PCB patterning and layout design.

#### 8. Halogen-free

The connector does not contain chlorine and bromine over the standard level.

All materials and substances used to produce this product comply with Halogen-free standards.\* Defined in accordance with to 61249-2-21. Br: 900 ppm max, Cl: 900 ppm max, Br+Cl: 1500 ppm max.

#### 9. Supports automatic pick-n-place mounting

Offered in tape and reel packaging that is compatible with automatic machine mounting. (5,000 pieces per reel)

The standard packaging is 5,000 pieces per reel, but it is also offered in a 500 pieces per reel. (The outer diameter of the reel will be  $\phi$ 180 mm in this case.)

FH53 differential impedance  
130ps rise time (20–80%)

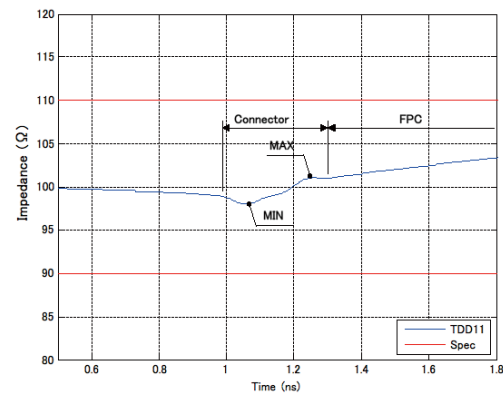
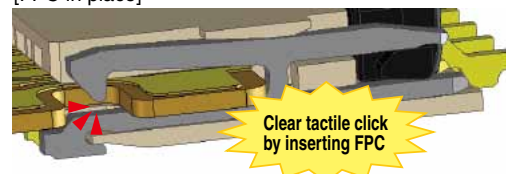

Fig. 2

Multi-functional chucking metal

[FPC in place]



[Locked]

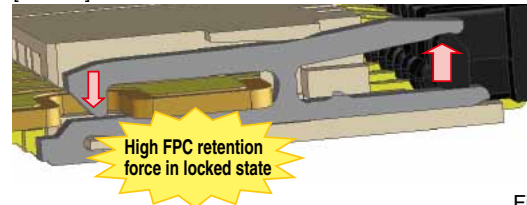
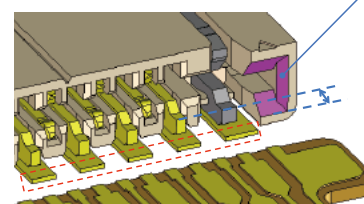

Fig. 3

Smooth FPC insertion



The bottom of the opening is tapered to allow easier FPC insertion

Efficient use of space with no dead areas

The tapers are located in front of the SMT leads

Smooth FPC insertion

Fig. 4

## Product Specifications

Rating	Current rating 0.2 A (Note 1) Voltage rating AC 30 Vrms	Operating Temperature Range -55 to 85°C (Note 2) Operating Humidity Range Relative humidity 90% MAX (condensation)	Storage Temperature Range -10 to +50°C (Note 3) Storage Humidity Range Relative humidity 90% MAX (condensation)
--------	--	---	--

Recommended FPC SPC	t=0.12±0.02 Gold plated
---------------------	-------------------------

Item	Specification	Conditions
1. Insulation Resistance	50 MΩ min	100 V DC
2. Withstanding Voltage	No flashover or insulation breakdown	90 Vrms AC/1 min
3. Contact Resistance	300 mΩ Max. *including FPC conductor resistance	1 mA
4. Durability	Contact Resistance: 300 mΩ Max. No damages, cracks and looseness of parts	10 cycles
5. Vibration	No electrical discontinuity to 1μ or longer Contact Resistance: 300 mΩ Max. No damages, cracks and looseness of parts	Frequency: 10 to 55 Hz, Half amplitude: 0.75 mm, for 10 cycles in 3 directions.
6. Shock	No electrical discontinuity to 1μ or longer Contact Resistance: 300 mΩ Max. No damages, cracks and looseness of parts	981 m/s <sup>2</sup> , Duration of pulse 6 ms at 3 times in 3 axial directions.
7. Humidity (Steady State)	Contact Resistance: 300 mΩ Max. Insulation Resistance: 50MΩ min No damages, cracks and looseness of parts	96 hours at 40°C and humidity of 90 to 95%
8. Temperature Cycle	Contact Resistance: 300 mΩ Max. Insulation Resistance: 50 MΩ min No damages, cracks and looseness of parts	Temperature:-55 → +15 to +35 → +85 → +15 to +35°C Time: 30 → 2 to 3 → 30 → 2 to 3 minutes 5 cycles with above conditions
9. Resistance to soldering heat	No deformation of case of excessive looseness of the terminal	Reflow: Recommended Temperature Profile manual soldering: 350±10°C, 5 seconds

(Note 1) When electrifying rated current to all contacts, use 70% of rated current.

(Note 2) Including temperature rise caused by current flow.

(Note 3) The term "storage" refers to the long-term storage condition of unused products before PCB mounting.

For no-electrification state after PCB mounting, the operating temperature and humidity are applied.

## Materials

Part	Material	Treatment	UL Regulation
Insulator	LCP	Beige	UL94V-0
	PA	Black	UL94HB
Contact	Phosphor bronze	Nickel barrier gold plated	—
Metal fitting	Phosphor bronze	Pure tin reflow plated	—

## Product Number Structure

Refer to this page when determining product specifications by model types. Please place orders with part numbers listed in this catalog. The characteristics and specifications of the product described in this catalog are reference values. Please make sure to check the latest delivery specifications at the time of product use.

### FH 53 - 41S - 0.2 SHW (99)

①      ②      ③      ④      ⑤      ⑥

① Series Name: FH	⑤ Terminal Type SHW...SMT horizontal staggered mounting type
② Series No.: 53	
③ No. of contacts: 41	
④ Contact Pitch: 0.2mm	
⑥ Specifications None: Regular (5000 per reel) (99) : 500 per reel	

### Connector Dimensions

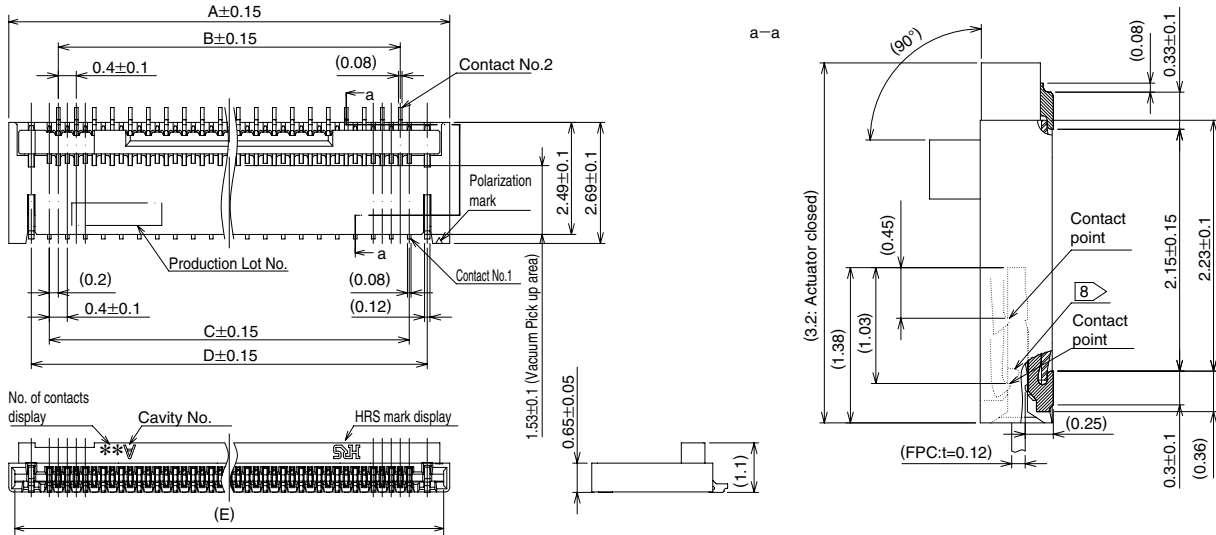

- Notes
- The dimension in parentheses are for reference.
  - Lead co-planarity including reinforced chucking metals shall be 0.1 max.
  - To be delivered with tape and reel packages.  
See attached packaging specifications for details.
  - Note that preventive hole for sink mark or slit could be added for improvement.
  - The quality remains good, even with the dark spots, which could occasionally occur on molded plastic.
  - The color of the plating may change after the reflow process, but it will not negatively affect performance of these connectors.
  - This product satisfies halogen free requirements defined as 900ppm maximum chlorine, 900ppm maximum bromine, and 1500ppm maximum total of chlorine and bromine.
- ⑧ Shows hook part of the chucking metal.

Unit: mm

Part number	HRS No.	Number of contacts	A	B	C	D	E
FH53-21S-0.2SHW(**)	-	21	5.8	3.6	4	4.8	5.53
FH53-31S-0.2SHW(**)	-	31	7.8	5.6	6	6.8	7.53
FH53-41S-0.2SHW(**)	580-3401-7 **	41	9.8	7.6	8	8.8	9.53
FH53-51S-0.2SHW(**)	-	51	11.8	9.6	10	10.8	11.53

### Recommended PCB Mounting Pattern

### Recommended Stencil Pattern

Recommended stencil thickness : t=01

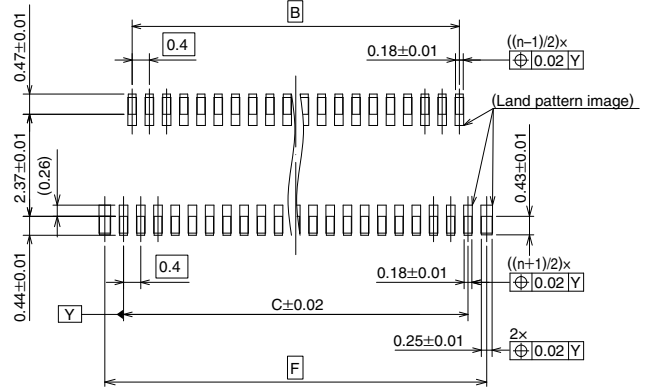
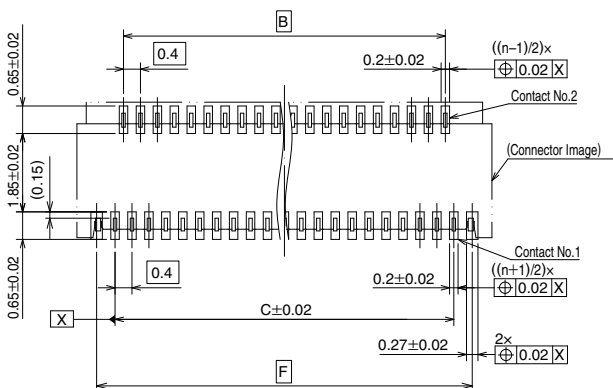

Notes 9. 'n' shows the number of contacts.

Unit: mm

Part number	HRS No.	Number of contacts	B	C	F
FH53-21S-0.2SHW(**)	-	21	3.6	4	4.87
FH53-31S-0.2SHW(**)	-	31	5.6	6	6.87
FH53-41S-0.2SHW(**)	580-3401-7 **	41	7.6	8	8.87
FH53-51S-0.2SHW(**)	-	51	9.6	10	10.87

\*\* Indicates a specification number of product. For detail, please refer to Page 2.

### Recommended FPC Pattern

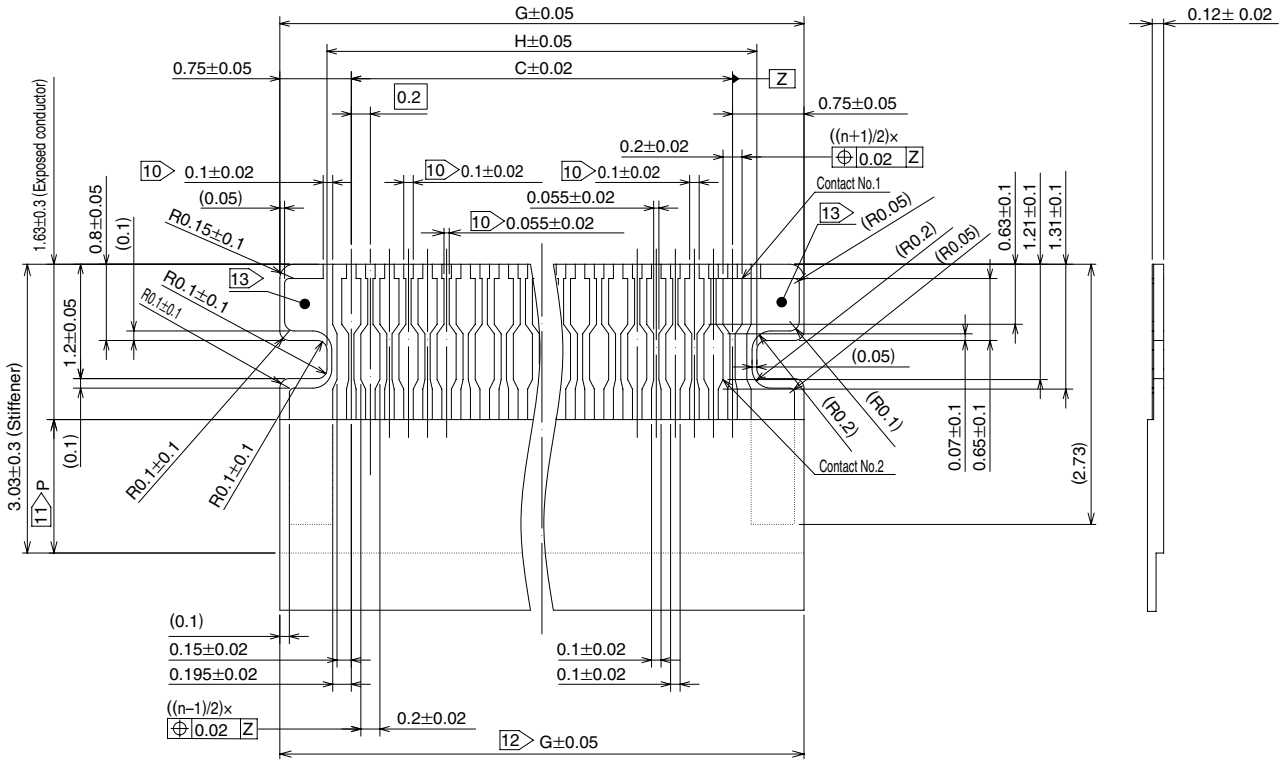

- Notes
- 10 Shows recommended dimension when lead for plating is required.
  - 11 Dimension P must be 1 mm minimum.
  - 12 Indicated tolerance is applicable to the exposed conductor.
  - 13 Both end side of contact pad on FPC can not be used for signal transmission.

Unit: mm

Part number	HRS No.	Number of contacts	C	G	H
FH53-21S-0.2SHW(**)	-	21	4	5.5	4.51
FH53-31S-0.2SHW(**)	-	31	6	7.5	6.51
FH53-41S-0.2SHW(**)	580-3401-7 **	41	8	9.5	8.51
FH53-51S-0.2SHW(**)	-	51	10	11.5	10.51

### FPC Construction Recommended Specifications

MATERIAL NAME	MATERIAL	THICKNESS (μm)
Cover film layer.	polyimide 1mil	25
Cover adhesive		25
Surface treatment	1 μm to 6 μm nickel under plated 0.2 μm gold plated	(4)
Copper foil	Cu 1/3oz	12
Base adhesive	Heat-hardened adhesive	No adhesion material
Base film	Polyimide 1mil	25
Reinforcement material adhesive	Heat-hardened adhesive	30
Stiffeder	Polyimide 2mil	50

### Precautions

1. This specification is recommendation for the construction of the FH53 series FPC ( $t=0.12 \pm 0.02$ )
2. For details about the construction, please contact FPC manufacturers.

## ◆ Packaging Specifications

### ● Embossed Carrier Tape Dimensions

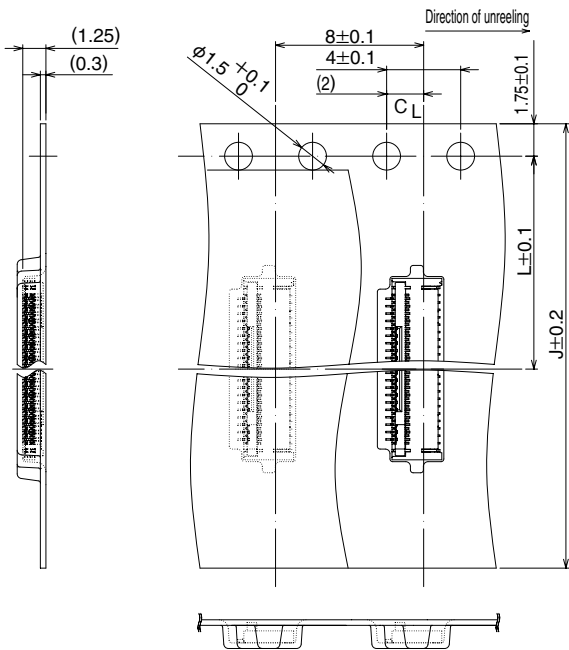

### ● Reel Dimensions

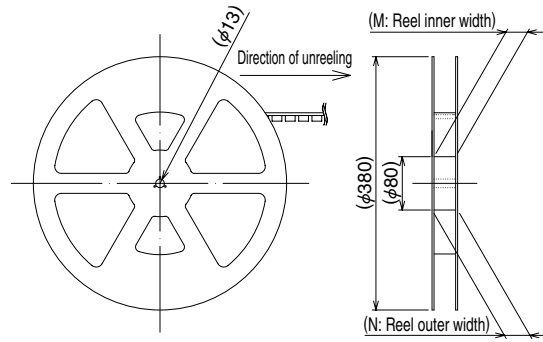

### ● Leader, Trailer Dimensions

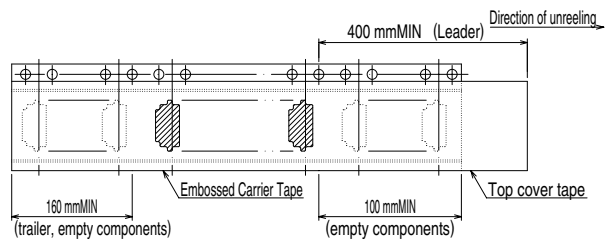

Unit: mm

Part number	HRS No.	Number of contacts	J	L	M	N
FH53-21S-0.2SHW(**)	-	21	16	7.5	17.4	21.4
FH53-31S-0.2SHW(**)	-	31	24	11.5	25.4	29.4
FH53-41S-0.2SHW(**)	580-3401-7 **	41	24	11.5	25.4	29.4
FH53-51S-0.2SHW(**)	-	51	24	11.5	25.4	29.4

## ◆ Temperature Profile

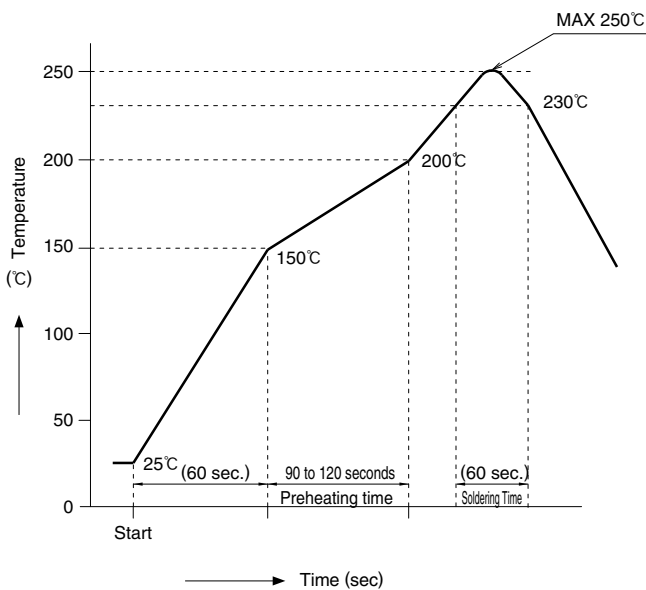

### Applicable Conditions

- Reflow method : IR/Hot air
- Reflow environment: Room air
- Solder : Paste type Sn/3.0Ag/0.5Cu (M705-GRN360-K2-V made by Senju Metal Industry Co.)
- Test PCB : PCB material and size  
Glass epoxy 25×50×0.8 mm  
Land size 0.2×0.65, 0.2×0.65 mm
- Stencil : Thickness 0.1 mm  
Opening size 0.18×0.47, 0.18×0.44 mm

This temperature profiles are based on the above conditions.

It may vary depending on solder paste type, manufacturer, PCB size and mounting materials. Please use only after checking the mounting conditions.

## ◆ Operation Methods of Connectors and Precautions

### Operation Methods

This connector features small, thin and back flip design, requiring delicate and careful handling.

#### 1. Initial condition

- ① Actuator does not have to be operated before inserting FPC, as the connector is delivered with the actuator opened.

[Caution]

- Do not close the actuator before inserting FPC. Closing the actuator without FPC could make the contact gap smaller, which could increase the FPC insertion force.

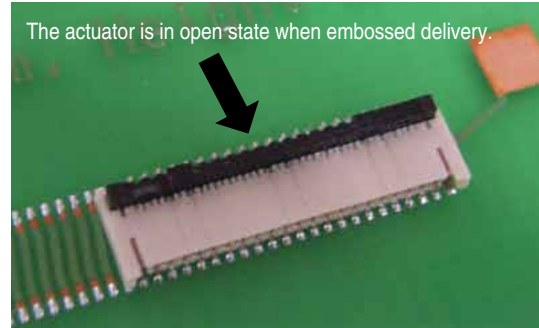

#### 2. How to insert FPC

- ① This connector has contacts on the top. Insert the FPC with the exposed conductors face up.

[Caution]

- Insert the FPC with the actuator opened.
- Do not twist the FPC to up and down, right and left or an angle. (It may cause a deformity of contact and contact failure.)

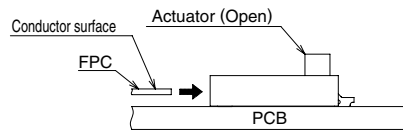

— Correct Operation —

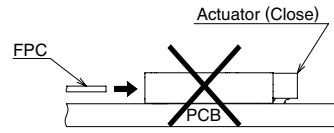

— Incorrect Operation —

#### 3. FPC insertion check

Chucking metals guide the FPC tabs to the correct position.

Make sure that the FPC tabs are located in proper position as shown in the figure below after FPC insertion.

Incomplete FPC insertion



NG

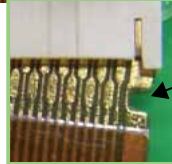

FPC cutout

Through the FPC cutout, PCB is visible

Correct FPC insertion

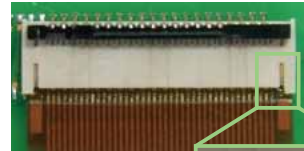

OK

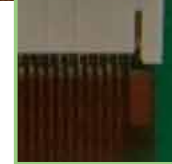

The FPC cutout is hidden by the connector housing and PCB is not visible from the cutout

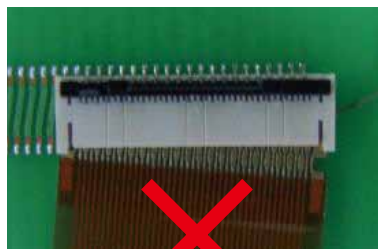
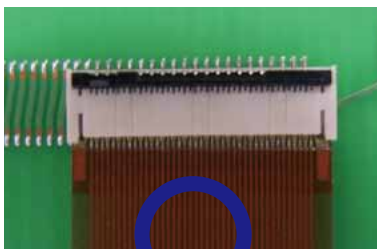

## Operation Methods

### 4. How to lock

- Apply load to rotate the actuator by 90 degree after inserting the FPC.
  - Operate the actuator by hand without using sharp tool such as Tweezers.
  - To close the actuator, operate at the center of the actuator.
  - To close the actuator, do not operate the actuator at one end only.
  - Do not apply excess force to the housing during the operation.

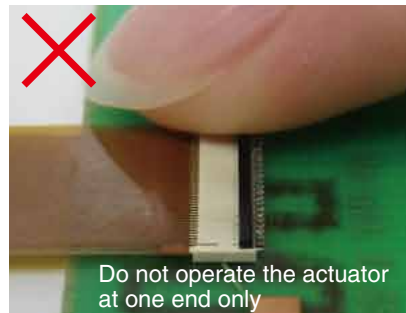
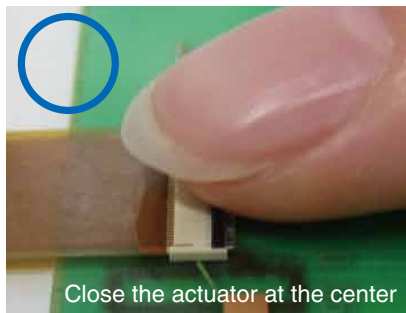
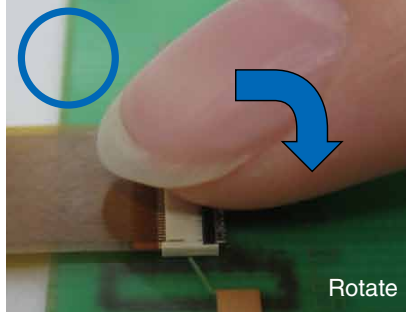

### 5. How to remove FPC (How to unlock FPC)

- Slowly flip up the actuator to release the lock. After rotating the actuator to the fully opened position carefully withdraw the FPC.
  - To open the actuator, operate at the center of the actuator. (Do not lift up only one side of the actuator. The actuator can be twisted causing damage.)
- \*The actuator is opened up to the movable limit 90 degree.  
Do not open the actuator beyond the specified degree or apply excess force to the actuator.

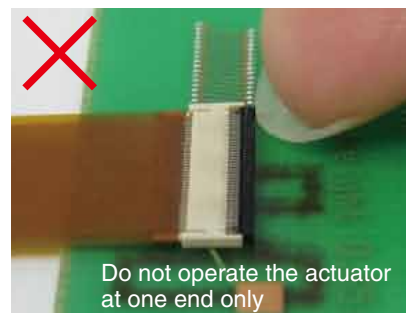
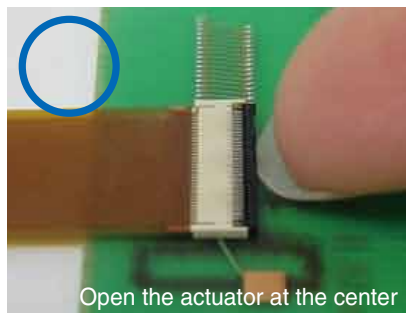
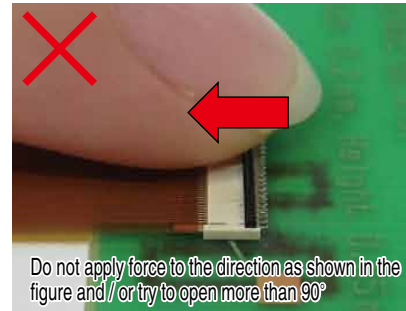
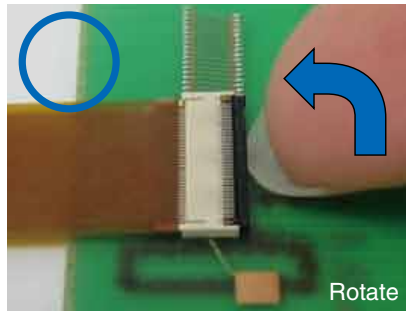

\*This connector utilizes a back flip system; the actuator is placed on the side opposite of the FPC insertion opening. Do not attempt to open the actuator from the FPC insertion side.

### Operation Methods

#### 6. FPC routing after connection

① Depending on a FPC rounding, a load is applied to connector, and a contact failure may occur. To prevent a failure, take the following notes into a consideration during mechanism design.

[Caution]

- Make sure that FPC and stiffener do not contact chassis.
- Avoid applying forces to FPC in vertical or horizontal directions.

In addition, avoid pulling up and down on the FPC.

- When fixing FPC after FPC cabling, avoid pulling FPC, and route the wire FPC with slack.

In this regard, the stiffener is parallel to the PCB.

- Do not mount other components touching to the FPC underneath the FPC stiffener.

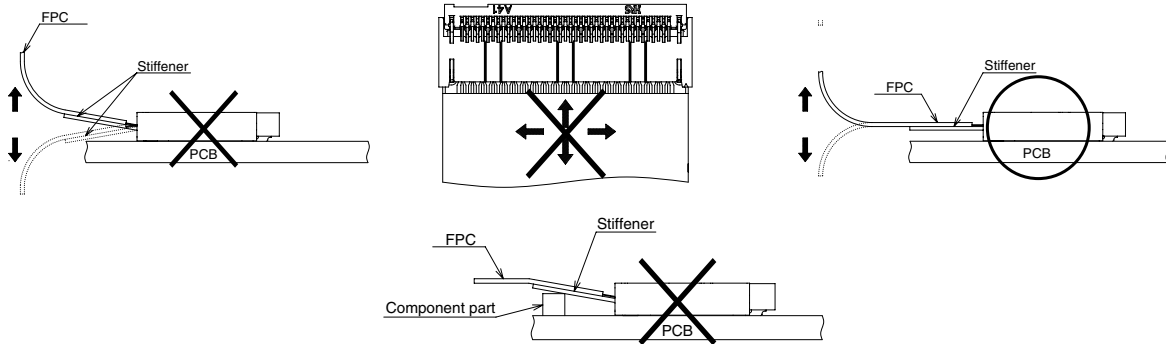

### Cautions when Mounting PCB

#### ◆ Warp of PCB

Minimize warp of the PCB as much as possible.  
Lead co-planarity including reinforced metals is 0.1 mm or less.  
Too much warp of the PCB may result in a soldering failure.

#### ◆ Flexible board design

Please make sure to put a stiffener on the backside of the flexible board.  
We recommend a glass epoxy material with the thickness of 0.3 mm MIN.

#### ◆ Load to Connector

Do not add 0.5N or greater external force when unreel or pick and place the connector etc, or it may get broken.  
In addition, do not insert the FPC or operate the connector before mounting.

#### ◆ Load to PCB

- Splitting a large PCB into several pieces
  - Screwing the PCB
- Avoid the handling described above so that no force is exerted on the PCB during the assembly process. Otherwise, the connector may become defective.

#### ◆ Instructions on manuel soldering

Follow the instructions shown below when soldering the connector manually during repair work, etc.

- ① Do not perform manual soldering with the FPC inserted into the connector.
  - ② Do not heat the connector excessively. Be very careful not to let the soldering iron contact any parts other than connector leads. Otherwise, the connector may be deformed or melt.
  - ③ Do not supply excessive solder (or flux).
- If excessive solder (or flux) is supplied on the terminals, solder or flux may adhere to the contacts or rotating parts of the actuator, resulting in poor contact or a rotation failure of the actuator. Supplying excessive solder to the chucking metals may hinder actuator rotation, resulting in breakage of the connector.

